

High Power White LEDs

SST-20-WxS

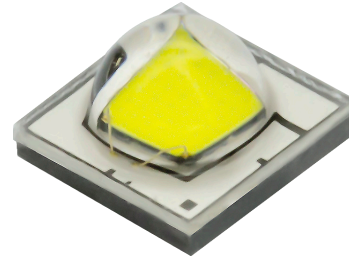

Table of Contents

Ordering Part Numbers	2
Binning Information	3
Chromaticity Binning Structure	4
Product Characteristics	6
Soldering Profile	9
Precautions for Use	10
Mechanical Dimensions	11
Tape and Reel	13
Packaging and Labeling	14
History of Changes	16

Features

- High brightness cool white LEDs with maximum output in excess of 1000 lm @ 3A, 85°C.
- High lumen density of monolithic emitter, up to 518 lm/mm²(6500K), ideal for maximizing the optical efficiency in high-output, beam pattern critical lighting applications.
- Maximum Drive Current: 3 A
- Luminous Efficacy: typ. 206 lm/W @ 350 mA, 85°C (6500K)
- Color Temperature: 5000K, 5700K, 6500K
- Color Rendering Index: min. 65, typ. 70
- Low thermal resistance: 1.6° C/W
- ANSI-compatible chromaticity bins
- LM-80 10,000-hr test data available, excellent TM-21 lifetime and color stability
- Available in 2 soldering footprint configurations
- Electrically isolated thermal path
- 8 kV HBM ESD rating per ANSI/ESDA/JEDEC JS-001
- RoHS and REACH compliant

Applications

- | | |
|-------------------------------|--------------------------------|
| • Portable Lights | • LED Work Lights |
| • Bicycle Lights | • Outdoor and Roadway Lighting |
| • Automotive Auxiliary Lights | • High Bay Industrial Lighting |

Ordering Part Numbers

CCT	Minimum Flux Bin ¹	Minimum Flux (lm)	Chromaticity Bin Kit Code ²	Solder Pad Type ³	Ordering Part Numbers
5000K	L4	585	501	A	SST-20-WDS-A120-L4501
				B	SST-20-WDS-B120-L4501
	L5	620	502	A	SST-20-WDS-A120-L4502
				B	SST-20-WDS-B120-L4502
	L4	585	501	A	SST-20-WDS-A120-L5501
				B	SST-20-WDS-B120-L5501
L5	620	502	A	SST-20-WDS-A120-L5502	
			B	SST-20-WDS-B120-L5502	
5700K	L4	585	571	A	SST-20-WDS-A120-L4571
				B	SST-20-WDS-B120-L4571
	L5	620	572	A	SST-20-WDS-A120-L4572
				B	SST-20-WDS-B120-L4572
	L4	585	571	A	SST-20-WDS-A120-L5571
				B	SST-20-WDS-B120-L5571
L5	620	572	A	SST-20-WDS-A120-L5572	
			B	SST-20-WDS-B120-L5572	
6500K	L4	585	651	A	SST-20-WCS-A120-L4651
				B	SST-20-WCS-B120-L4651
	L5	620	652	A	SST-20-WCS-A120-L4652
				B	SST-20-WCS-B120-L4652
	L4	585	651	A	SST-20-WCS-A120-L5651
				B	SST-20-WCS-B120-L5651
L5	620	652	A	SST-20-WCS-A120-L5652	
			B	SST-20-WCS-B120-L5652	

Notes

1. The Ordering Part Number specifies the Minimum Flux Bin in shipment; higher flux bins may be shipped without advance notice. Please refer to 'Luminous Flux Binning' table for details of all flux bins.
2. Shipments always adhere to the color bins specified in each Chromaticity Bin Kit. See 'Chromaticity Bin Kit Codes' table for the color bins included in each Bin Kit.
3. See 'Mechanical Dimensions' for A and B types' solder pad configurations. All product mechanical, electrical and optical specifications are otherwise identical.

Part Number Nomenclature

SST — 20 — W<xy> — <p###> — <ffcc>

Product Family	Light Emission Area	Light Color	Package Configuration	Bin Kit
S: Surface Mount S: Dome Lensed T: Single Emitter	20: 2.0 mm ²	W: White <x> Color Temperature C: Cool White D: Daylight White <y> CRI Category Code S: CRI>65	<p> Solder Pad Configuration A: type A - see page 11 B: type B - see page 12 <###> Viewing angle 120: 120°	<ff> Minimum Flux Bin, see 'Luminus Flux Binning' table for details <ccc> Chromaticity Bin Kit, see 'Chromaticity Bin Kit Codes' table for details

Luminous Flux Binning

Flux Bin Code	Binning @ 1500 mA, T _j =85°C ¹		@ 350 mA, T _j =25°C ²	Correlated Minimum Flux (lm) @ T _j =85°C ²			
	Minimum Flux (lm)	Maximum Flux (lm)	Minimum Flux (lm)	350 mA	700 mA	2000 mA	3000 mA
L3	560	585	180	157	297	700	941
L4	585	620	187	164	310	731	983
L5	620	665	200	174	330	775	1042
M2	665	705	213	186	352	831	1117
M3	705	745	226	197	374	881	1184

Notes

- LEDs are measured at 25°C ambient temperature with 1500 mA 20ms single pulse. The measured values are correlated to 1500 mA at 85°C junction temperature (T_j). Luminus maintains a ±6% tolerance on flux measurement.
- Flux values at other junction temperature (T_j) and/or forward current conditions are calculated and for reference only.

Forward Voltage Binning

Voltage Bin Code	Binning @ 1500mA, T _j =85°C	
	Minimum Voltage (V)	Maximum Voltage (V)
VH	2.5	2.7
VJ	2.7	2.9
VK	2.9	3.1
VL	3.1	3.3

Note: Individual voltage bins are not orderable.

Chromaticity Binning Coordinates

CCT	Bin Code	CIE _x	CIE _y	Bin Code	CIE _x	CIE _y	Bin Code	CIE _x	CIE _y	Bin Code	CIE _x	CIE _y
5000K	DA	0.3371	0.349	DB	0.3376	0.3616	DC	0.3463	0.3687	DD	0.3451	0.3554
		0.3451	0.3554		0.3463	0.3687		0.3551	0.376		0.3533	0.362
		0.344	0.3427		0.3451	0.3554		0.3533	0.362		0.3515	0.3487
		0.3366	0.3369		0.3371	0.349		0.3451	0.3554		0.3440	0.3427
	DH	0.3366	0.3369	DE	0.3381	0.3762	DF	0.348	0.384	DG	0.344	0.3428
		0.344	0.3428		0.348	0.384		0.3571	0.3907		0.3515	0.3487
		0.3429	0.3307		0.3463	0.3687		0.3551	0.376		0.3495	0.3339
		0.3361	0.3245		0.3376	0.3616		0.3463	0.3687		0.3429	0.3307
5700K	CA	0.3215	0.335	CB	0.3207	0.3462	CC	0.329	0.3538	CD	0.329	0.3417
		0.329	0.3417		0.329	0.3538		0.3376	0.3616		0.3371	0.349
		0.329	0.33		0.329	0.3417		0.3371	0.349		0.3366	0.3369
		0.3222	0.3243		0.3215	0.335		0.329	0.3417		0.3290	0.3300
	CH	0.3222	0.3243	CE	0.3196	0.3602	CF	0.329	0.369	CG	0.329	0.33
		0.329	0.33		0.329	0.369		0.3381	0.3762		0.3366	0.3369
		0.329	0.318		0.329	0.3538		0.3376	0.3616		0.3361	0.3245
		0.3231	0.312		0.3207	0.3462		0.329	0.3538		0.3290	0.3180
6500K	BA	0.3048	0.3207	BB	0.3028	0.3304	BC	0.3115	0.3391	BD	0.313	0.329
		0.313	0.329		0.3115	0.3391		0.3205	0.3481		0.3213	0.3373
		0.3144	0.3186		0.313	0.329		0.3213	0.3373		0.3221	0.3261
		0.3068	0.3113		0.3048	0.3207		0.313	0.329		0.3144	0.3186
	BH	0.3068	0.3113	BE	0.3005	0.3415	BF	0.3099	0.3509	BG	0.3144	0.3186
		0.3144	0.3186		0.3099	0.3509		0.3196	0.3602		0.3221	0.3261
		0.3161	0.3059		0.3115	0.3391		0.3205	0.3481		0.3231	0.312
		0.3093	0.2993		0.3028	0.3304		0.3115	0.3391		0.3161	0.3059

Chromaticity Binning Diagram

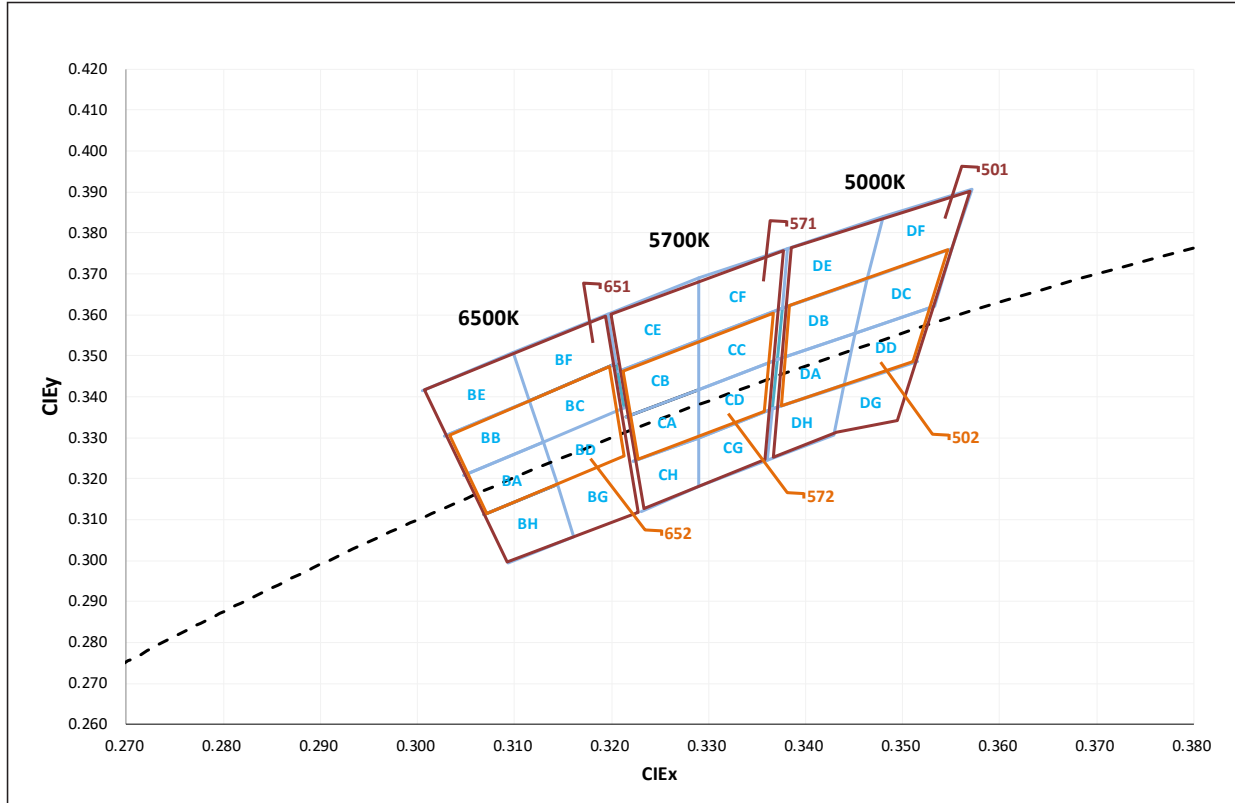

Chromaticity Bin Kit Codes

CCT	Bin Kit	Chromaticity Bins
5000K	501	DA, DB, DC, DD, DE, DF, DG, DH
	502	DA, DB, DC, DD
5700K	571	CA, CB, CC, CD, CE, CF, CG, CH
	572	CA, CB, CC, CD
6500K	651	BA, BB, BC, BD, BE, BF, BG, BH
	652	BA, BB, BC, BD

Note: Luminus maintains a tolerance of ± 0.005 on chromaticity (Cx, Cy), and ± 2 on Color Rendering Index (CRI) measurements.

Product Characteristics

Parameter	Symbol	Minimum	Typical	Maximum	Unit
Viewing Angle (FWHM)	$2\theta_{1/2}$		120		Degree
Color Rendering Index	CRI	65	70		
Thermal resistance (Electrical) Junction/Solder Point	$R_{thjs-EL}$		1.6		°C/W
Junction Temperature	T_j			150	°C
Forward Voltage (@ $I_f=1500$ mA, $T_j=85^\circ\text{C}$)	V_f	2.7	3.0	3.3	V
DC Forward Current	I_f	0.2		3	A
Surge Current (t < 10 ms, Duty Cycle < 10%)	I_{s-max}			4	A
Reverse Voltage ($I_r=10$ mA)	V_r			5	V
Power Dissipation	P_d			10	W
Operating Temperature	T_{opr}	-40		100	°C
Storage Temperature	T_{stg}	-40		100	°C
ESD withstand Voltage HBM Per ANSI/ESDA/JEDEC JS-001	V_{HBM}	8			kV
ESD withstand Voltage CDM Per ANSI/ESDA/JEDEC JS-002	V_{CDM}	1			kV

Optical & Electrical Characteristics

Relative Luminous Flux vs. Forward Current

$\Phi_v/\Phi_v(1.5\text{ A}), T_j = 85^\circ\text{C}$

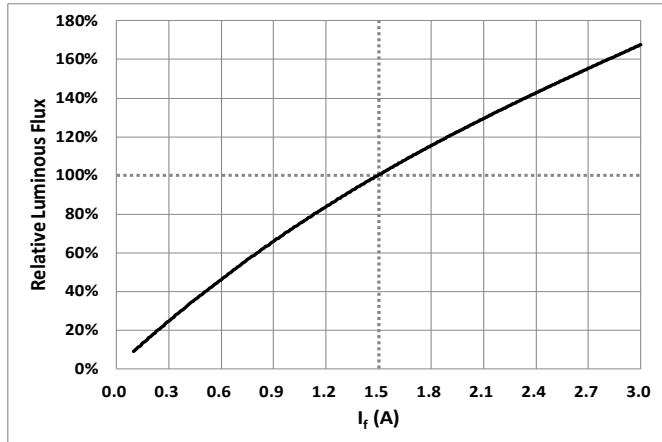

Relative Luminous Flux vs. Temperature (Tj)

$\Phi_v/\Phi_v(85^\circ\text{C}), I_f = 1.5\text{ A}$

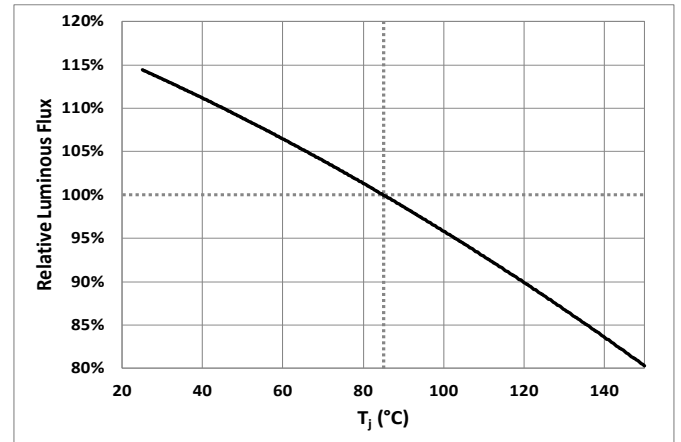

Forward Voltage vs. Forward Current

$V_f = f(I_f), T_j = 85^\circ\text{C}$

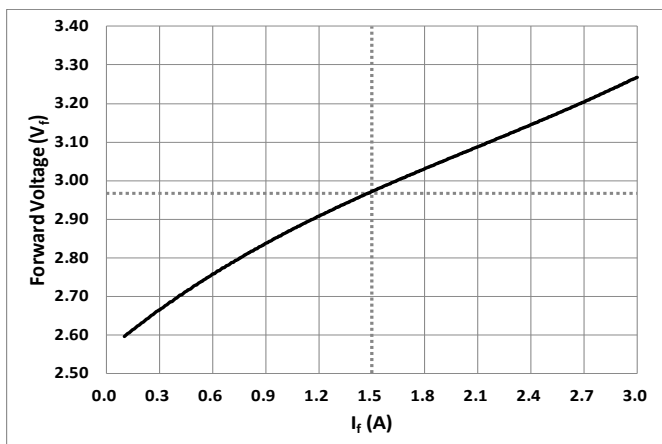

Relative Forward Voltage vs. Temperature (Tj)

$\Delta V_f = V_f(T_j) - V_f(85^\circ\text{C}), I_f = 1.5\text{ A}$

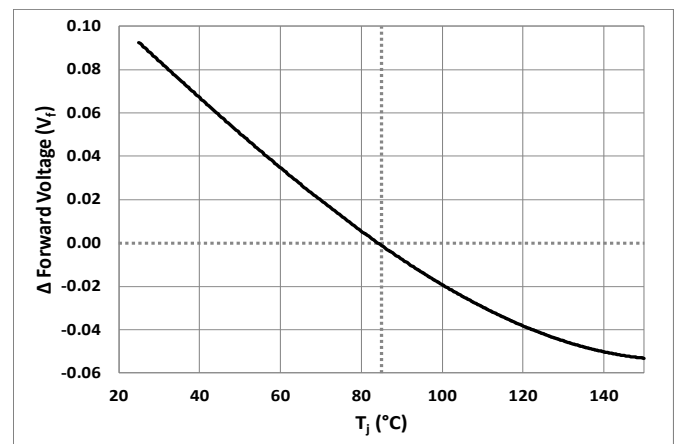

Relative Chromaticity vs. Forward Current

$\Delta \text{CIEx}, \Delta \text{CIEy} = \text{CIEx}, \text{y}(I_f) - \text{CIEx}, \text{y}(1.5\text{ A}), T_j = 85^\circ\text{C}$

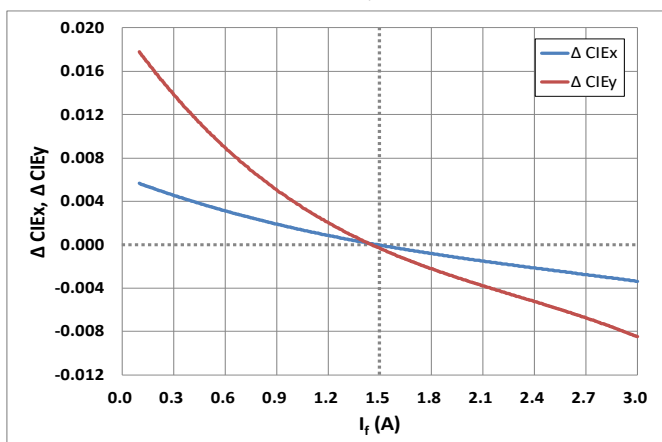

Relative Chromaticity vs. Temperature (Tj)

$\Delta \text{CIEx}, \Delta \text{CIEy} = \text{CIEx}, \text{y}(T_j) - \text{CIEx}, \text{y}(85^\circ\text{C}), I_f = 1.5\text{ A}$

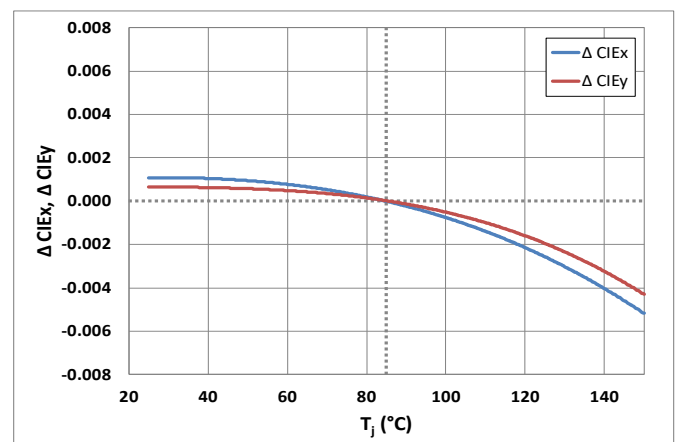

Relative Spectral Power Distribution

$I_f=1.5\text{ A}, T_j=85^\circ\text{C}$

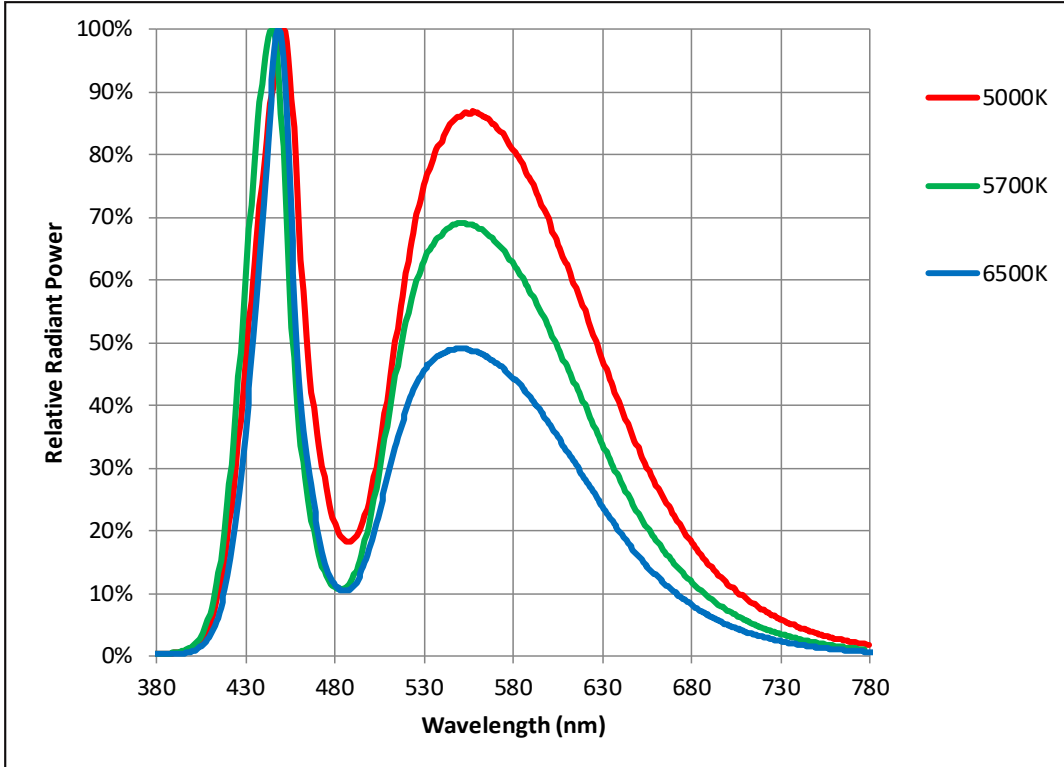

Typical Radiation Characteristics (A120 and B120 Types)

$I_f=1.5\text{ A}, T_j=25^\circ\text{C}$

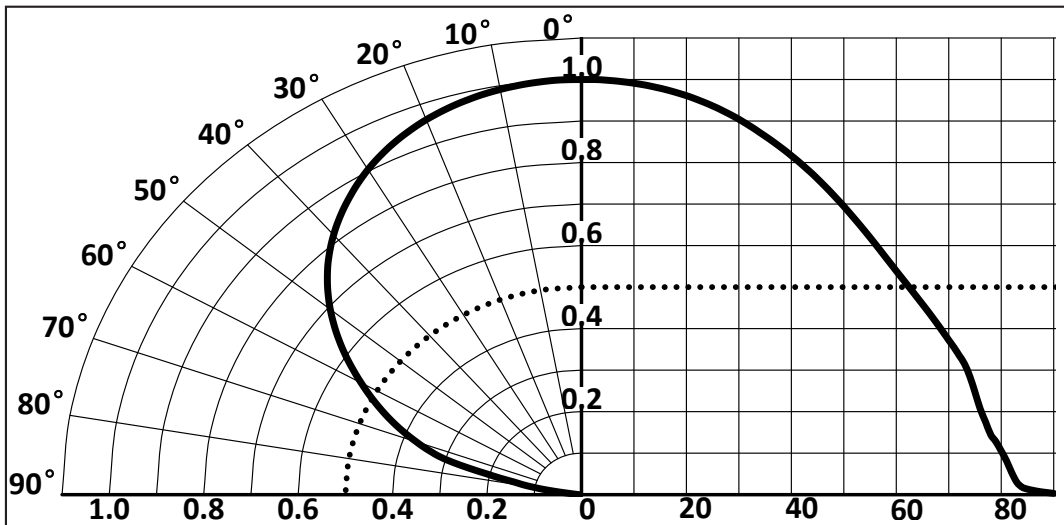

Soldering Profile

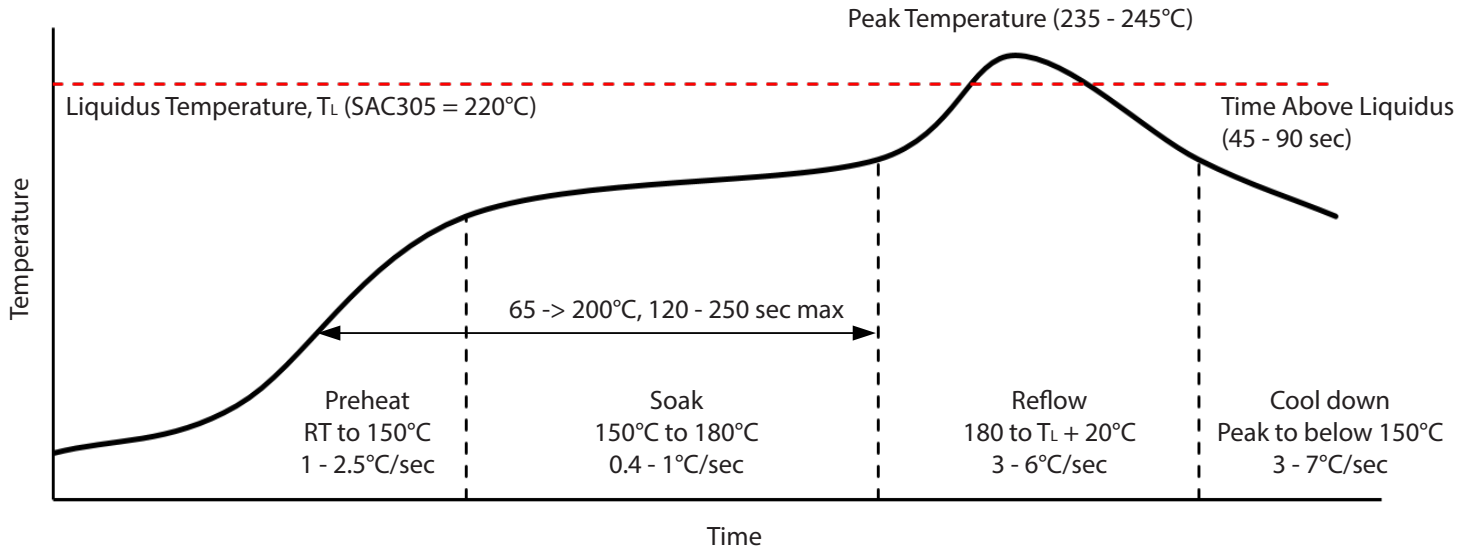

SMT Rework Guideline	Manual Hotplate Reflow	Hot Air Gun Reflow
Heating Time	< 60 sec	
Hotplate Temperature	< 245°C	< 150°C

Notes

- Product complies to Moisture Sensitivity Level 3 (MSL 3).
- The numbers in the table are specific to SAC305. Luminus recommends using an SAC305 solder paste with a no-clean flux for RoHS compliant products.
- During the pick and place process, axial forces on the dome (or window) should not exceed 0.5 Newtons (N).
- Use of a multi-zone IR reflow oven with a nitrogen blanket is recommended.
- Time-temperature profile of the reflow process showing the four functional profile zones are defined in IPC-7801. Temperature is referenced to the center of the PCB.
- Luminus recommends to use the solder paste data sheet information as a starting point in time-temperature process development.
- These are general guidelines. Consult the solder paste manufacturer's datasheet for guidelines specific to the alloy and flux combination used in your application. For more information, please refer to: <https://luminusdevices.zendesk.com/hc/en-us/articles/360060306692-How-do-I-Reflow-Solder-Luminus-SMD-Components->
- For any technical questions about soldering process, please contact Luminus at techsupport@luminus.com.

Precautions for Use

Storage:

1. Before opening the package

The LEDs should be kept at a temperature lower than 40°C and relative humidity lower than 90%. The LEDs should be used within a year. When storing the LEDs, moisture proof package with absorbent material (silica gel) is recommended.

2. After opening the package

The LEDs should be kept at a temperature lower than 30°C and relative humidity lower than 60%. The LEDs should be soldered within 168 hours (7 days) after opening the moisture proof package.

If unused LEDs remain, they should be stored in moisture proof packages, such as sealed containers with moisture absorbent material (silica gel). It is also recommended to return the unused LEDs to the original moisture proof package and to seal it again.

If the moisture absorbent material (silica gel) vaporizes or passes the expiration date, baking treatment should be performed by using the following conditions : 60°C for 20 hours.

The LED's electrode and lead frame comprise a silver plated copper alloy. The silver surface may be affected by environments. Please avoid conditions which may cause the LEDs to corrode or discolor. The corrosion or discoloration might lower solderability or affect optical characteristics.

Please avoid rapid transition in ambient temperature, especially in high humidity environments where condensation can occur.

Static Electricity:

1. The products are sensitive to static electricity, and care should be taken when handling them.

2. Static electricity or surge voltage will damage the LEDs. It is recommended to wear anti-electrostatic gloves or wristband when handling the LEDs.

3. All devices, equipment and machinery must be properly grounded. It is recommended that measures be taken against surge voltage to the equipment that mounts the LEDs.

A120 Package Configuration

Mechanical Dimensions

All dimensions are in millimeter ± 0.13 mm

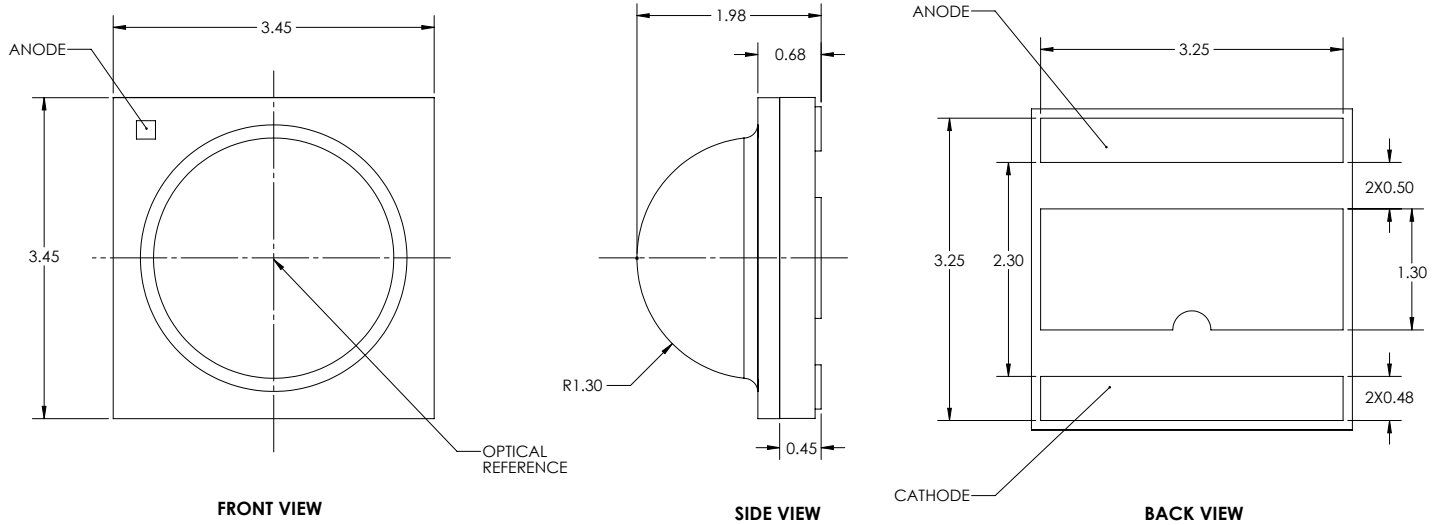

Recommended PCB Solder Pad and Stencil Pattern

All dimensions are in millimeter ± 0.13 mm

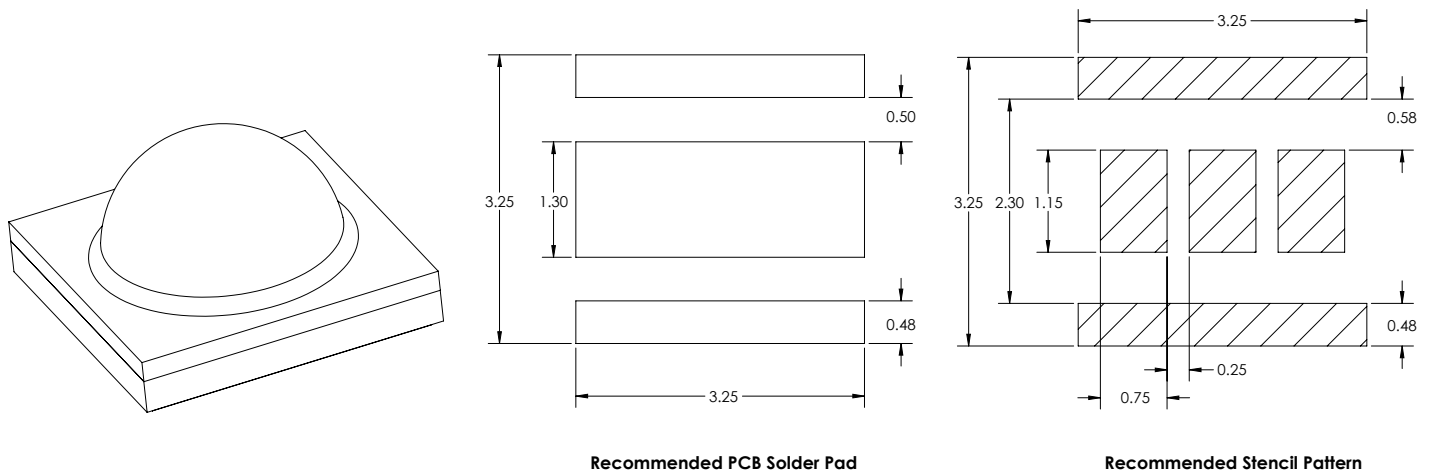

B120 Package Configuration

Mechanical Dimensions

All dimensions are in millimeter ± 0.13 mm

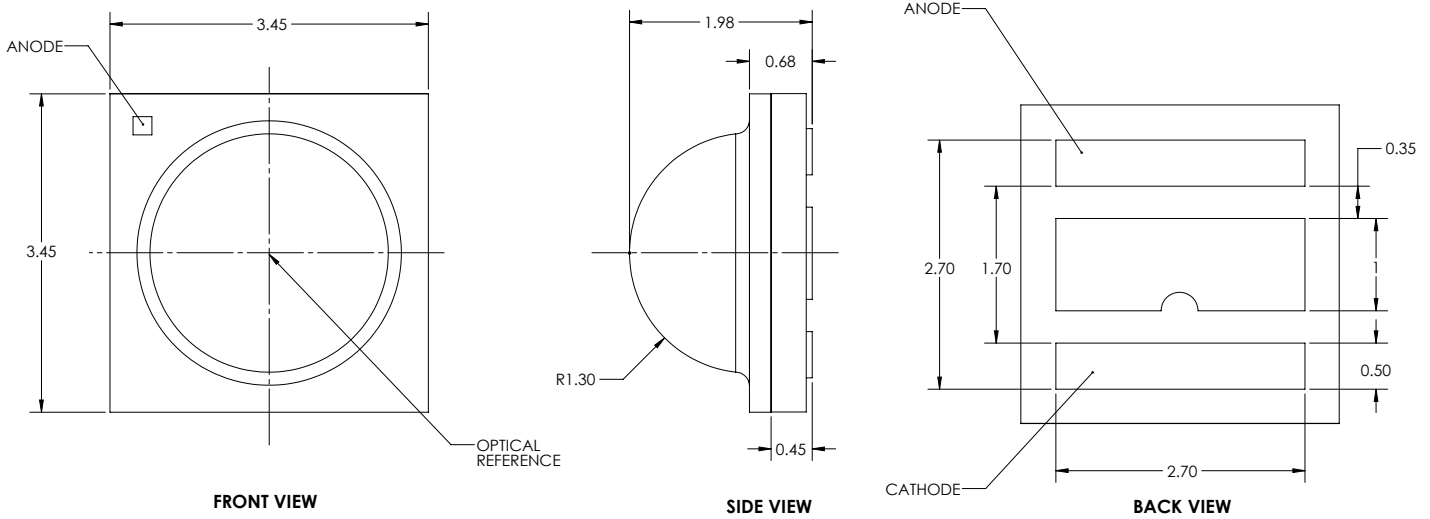

Recommended PCB Solder Pad and Stencil Pattern

All dimensions are in millimeter ± 0.13 mm

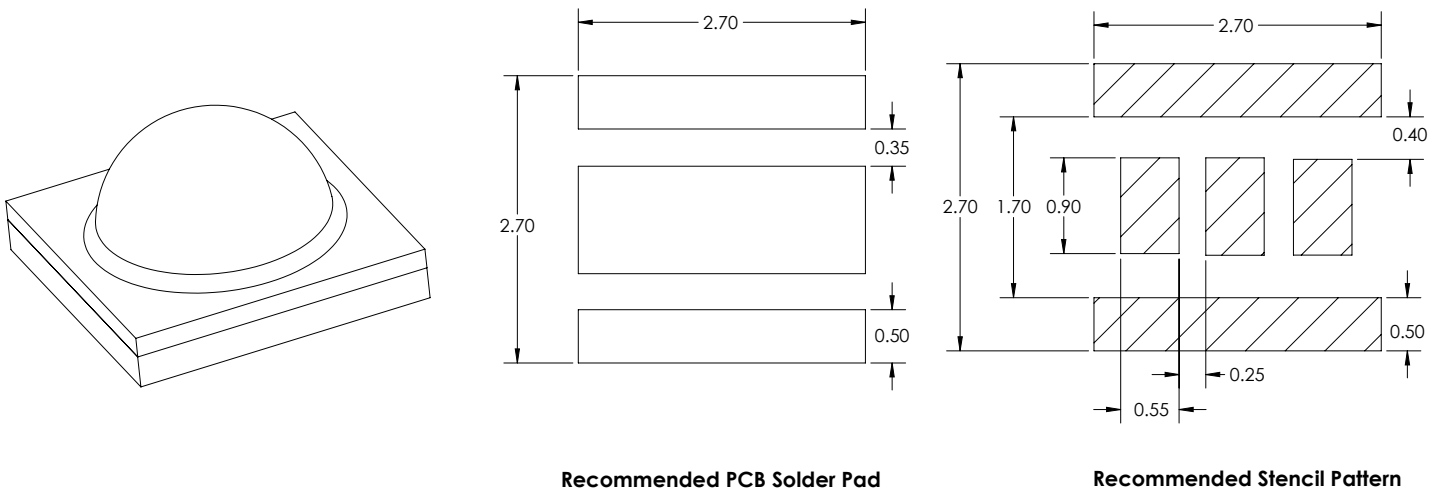

Tape and Reel - A120 and B120 Package Configurations

All dimensions are in millimeter ± 0.13 mm

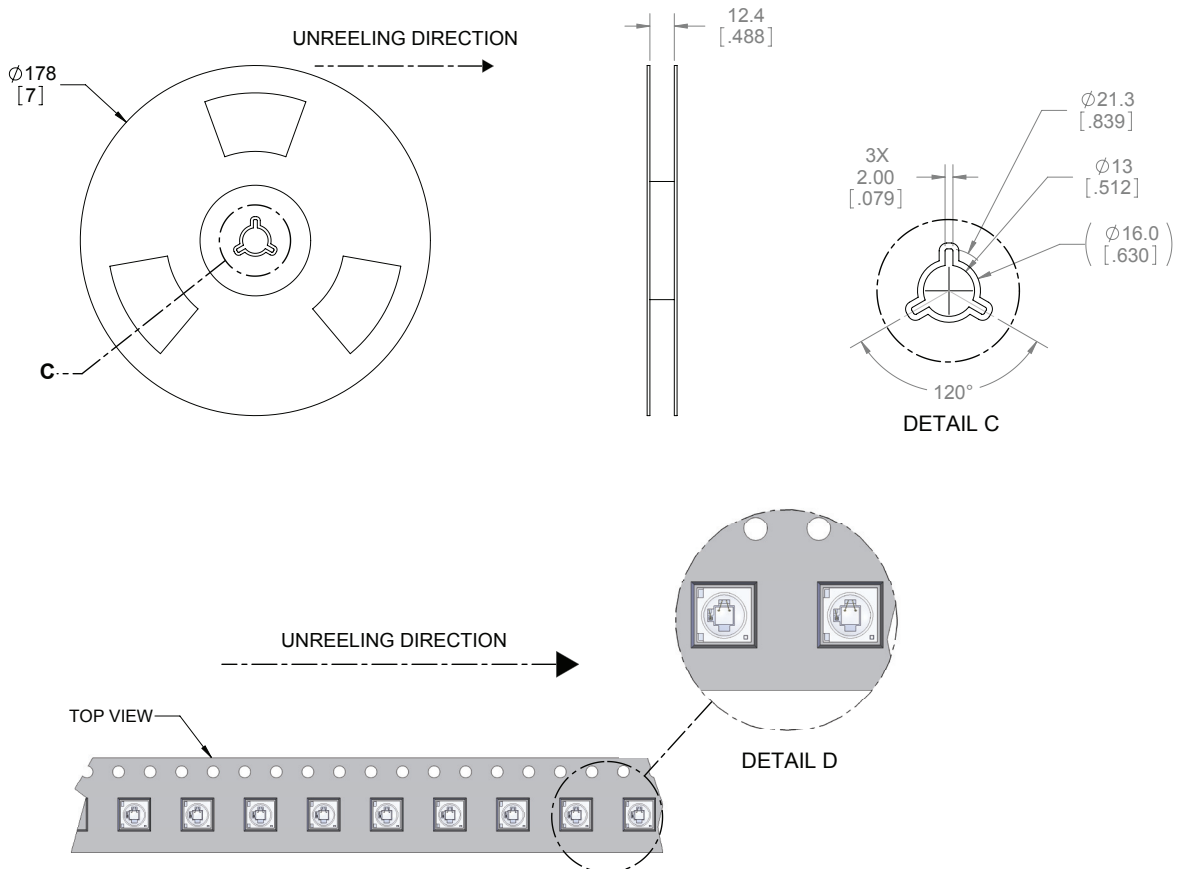
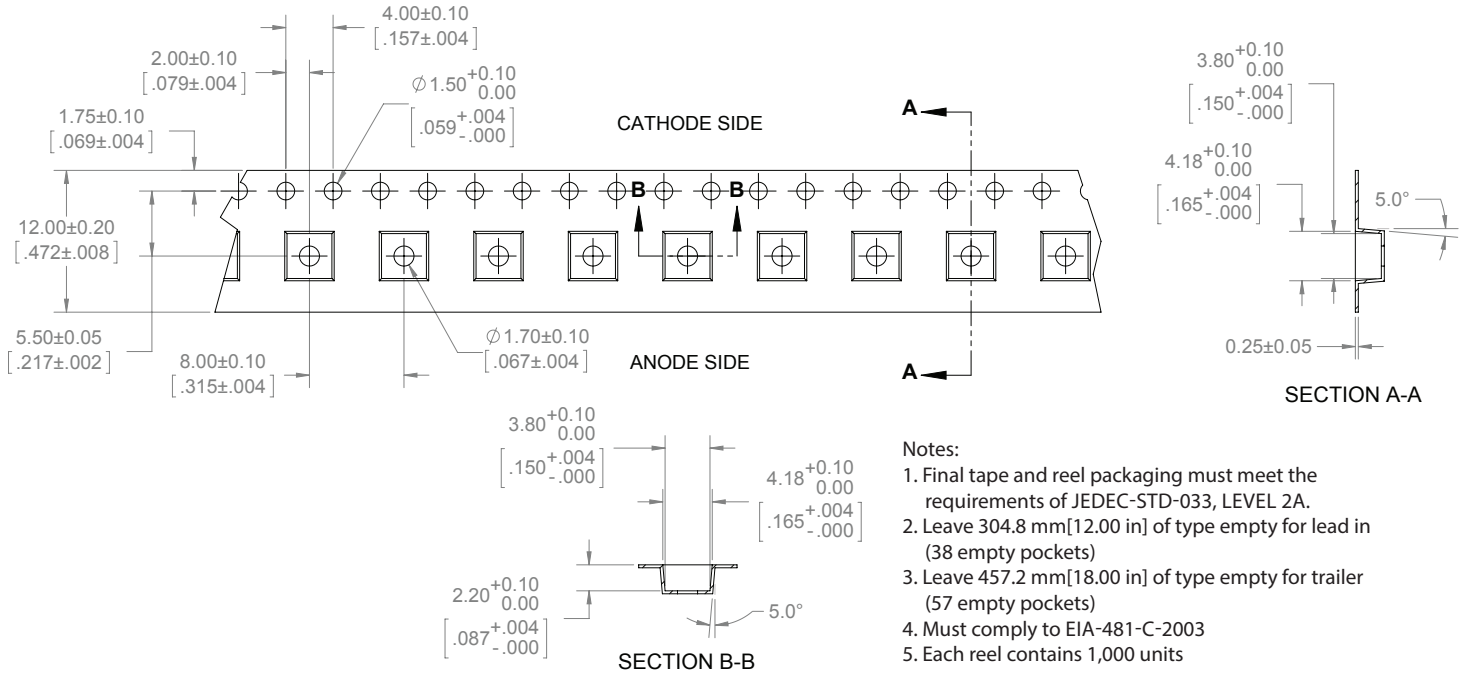

Packaging and Labeling

Packaged Reel

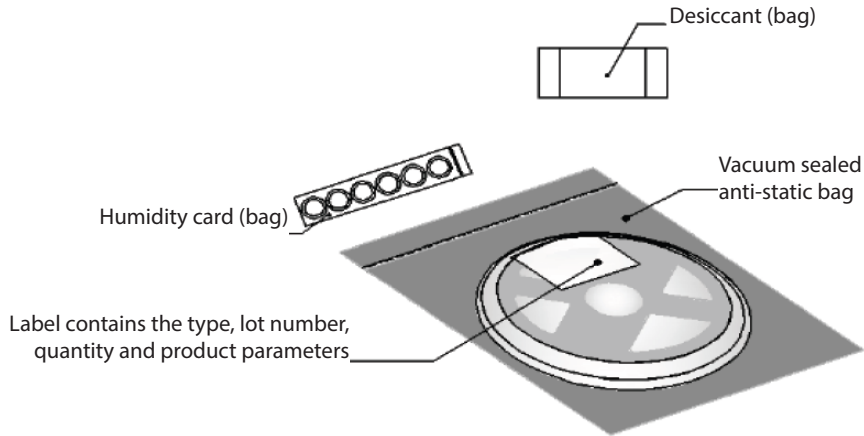

Label on Reel

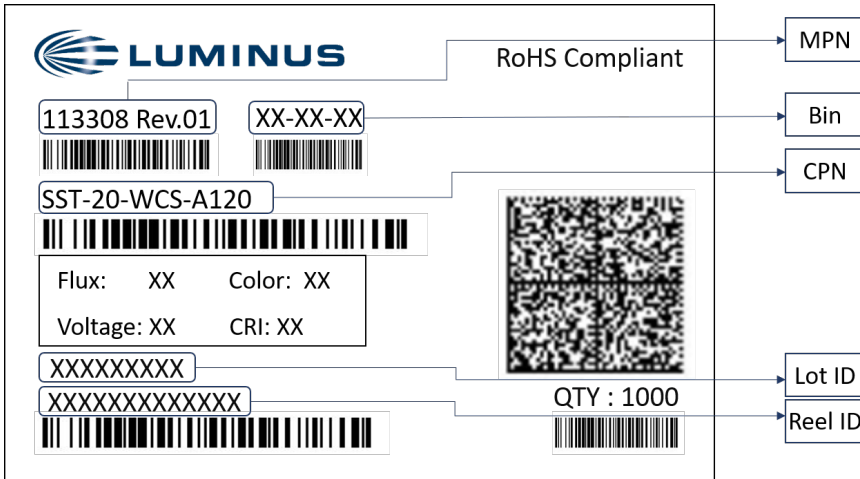

Label Information	
CPN	Luminus ordering part number
MPN	For Luminus internal use
QTY	Quantity of parts per reel
Flux	Single flux bin code (see <i>Luminous Flux Binning</i> table on page 3)
Voltage	Single voltage bin code (see <i>Forward Voltage Binning</i> table on page 3)
Color	Single chromaticity bin code (see <i>Chromaticity Bin Coordinates</i> table on page 4)
CRI	N/A
Lot ID & Reel ID	For Luminus internal use

Packaging Boxes

Box Size 1 - 5 reels per box
Size: 22.5 x 24.5 x 6.5 cm

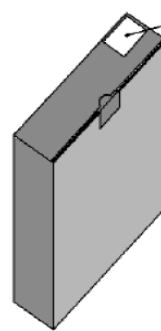
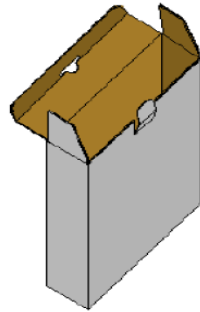

Label contains the type, lot number, quantity and product parameters

Box Size 2 - 10 reels per box
Size: 22.5 x 24.5 x 13 cm

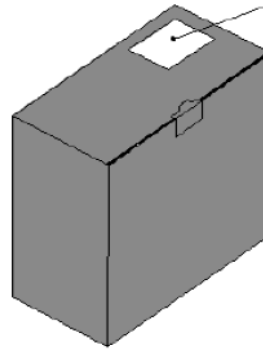
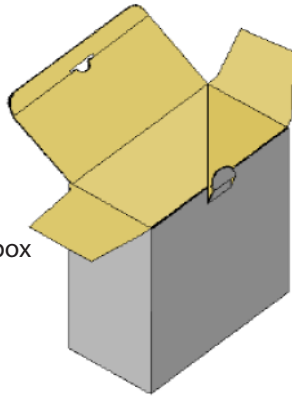

Label contains the type, lot number, quantity and product parameters

Shipping Label on Packaging Box

Multiple labels are attached to the box (one label per reel inside the box)

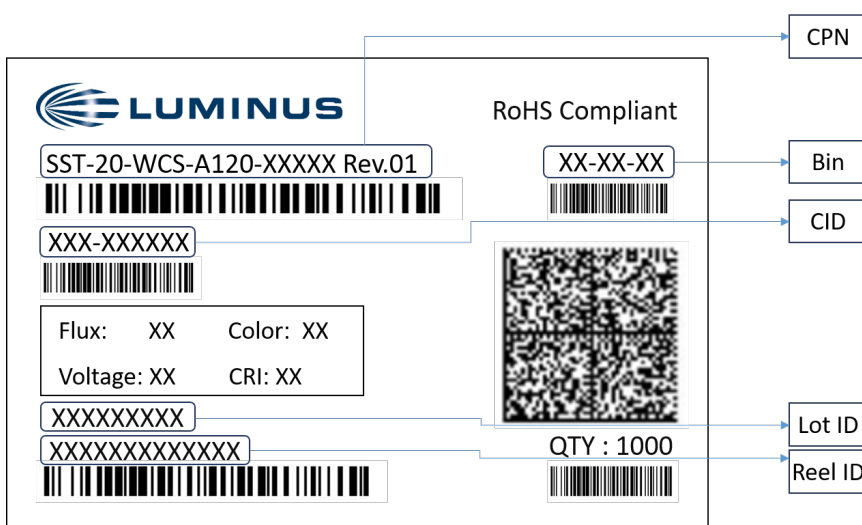

Label Information	
CPN	Luminus ordering part number
CID	Customer ID
QTY	Quantity of parts per reel
Flux	Single flux bin code (see <i>Luminus Flux Binning</i> table on page 3)
Voltage	Single voltage bin code (see <i>Forward Voltage Binning</i> table on page 3)
Color	Single chromaticity bin code (see <i>Chromaticity Bin Coordinates</i> table on page 4)
CRI	N/A
Lot ID & Reel ID	For Luminus internal use